

T4HD: Installation Supplement

R12.2.14



Smartscan Incorporated
33083 Eight Mile Road
Livonia MI 48152
Tel: (248)477-2900
Fax: (248) 477-7453
Web: www.smartscaninc.com

Smartsan Incorporated
Livonia, Michigan

T4HD

The use of this document is reserved exclusively for the use of Smartsan Incorporated customers and personnel. The information and drawings contained herein are the sole property of Smartsan Incorporated, and shall not be disclosed to any third party without the prior written consent for Smartsan Incorporated. Smartsan Incorporated makes no warranty of any kind with regard to this material, including but not limited to, implied warranties or fitness for a particular purpose. The information in this document is subject to change without notice. Smartsan shall not be liable for any errors contained herein for incidental or consequential damages in connection with the performance of use of this material.

In order for machinery to be guarded by the Smartsan T4HD light curtain system, the machinery must be capable of stopping at any point in the machine cycle. The guarded machine must be wired such that any interruption of the defined area will cause immediate arrest of the dangerous motion of the guarded machine.

Smartsans T4HD's ability to perform this function depends upon the appropriateness of the application and upon the Smartsan T4HD 's proper mechanical and electrical installation and interfacing to the machine being guarded. If all mounting, installation, interfacing and commissioning procedures are not followed properly the Smartsan T4HD system cannot provide the protection for which it was designed. The user has the responsibility to ensure all local, state, national laws, rules, codes or regulations relating to the installation and use of this system in any particular application are satisfied.

The user has the sole responsibility to ensure that the Smartsan T4HD system is installed and interfaced to the guarded machine by "qualified persons" in accordance with this manual and applicable safety regulations. A "qualified person" is defined as " a person or persons who, by possession of a degree or certificate of professional training, or who, by extensive knowledge, training and experience has successfully demonstrated the ability to solve problems relating to this subject matter and work" (ANSI/AME B30.2-1983)

Light Curtain Orientation

TX - Transmitter RX - Receiver

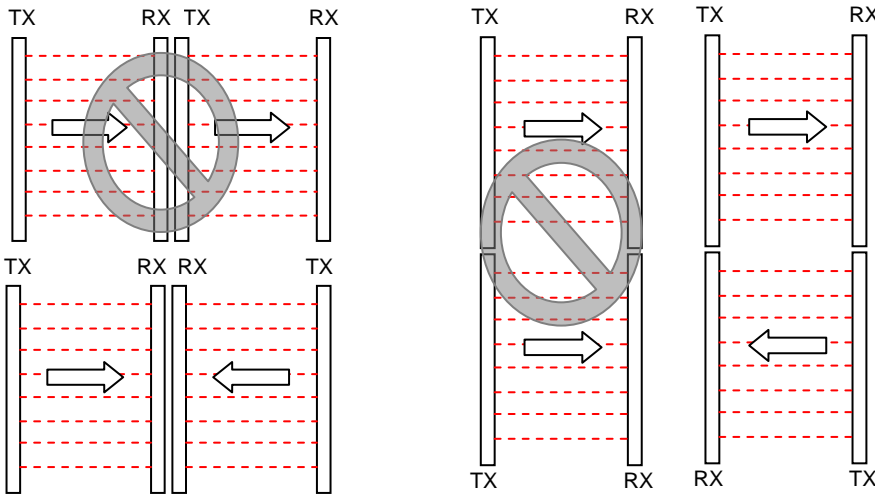

Proximity to reflective surfaces

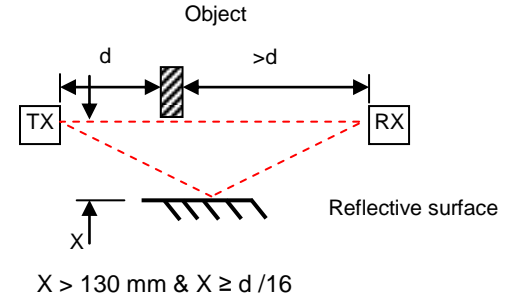

X is minimum distance between the light and the reflective surface. The closest distance of TX or RX to the object approaching the light curtain is d .

Use with Mirrors

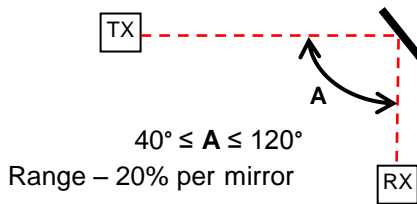

Light Curtain Alignment

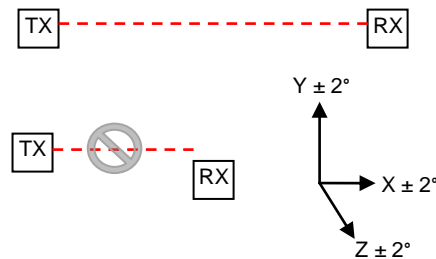

Optical Short Circuit Prevention

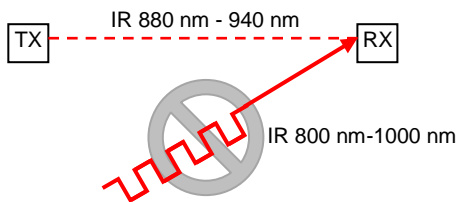

Light Curtain Mounting

Light curtain must be securely mounted such that the operator cannot reach the hazard without passing through the light curtain sensing region.

The operator should not be able to reach over, reach under or walk past the protective device without interrupting its sensing region. Additional guarding may be required to achieve this task.

Warning; Physical damage to the T4HD light curtain system could create an un-safe condition that may cause a serious injury including death. Contact Smartsan for more information.

Warning: Do not repair or modify the T4HD Light curtain. The T4HD safety light curtain is not site/field repairable and can only be repaired at the Smartsan.

Principle Of Operation

The Smartscan sensing unit consists of a transmitter and a receiver column that face each other across an area to be safeguarded. The transmitter (TX) contains a row of infrared, light emitting diodes that sequentially transmit parallel beams of infrared light to corresponding receiver diodes in the receiver (RX) column. When the control/monitoring unit detects an obstruction in the optical path of one, or more of the beams that form the sensing field, the Safety Outputs (OSSD's) will immediately turn-OFF.

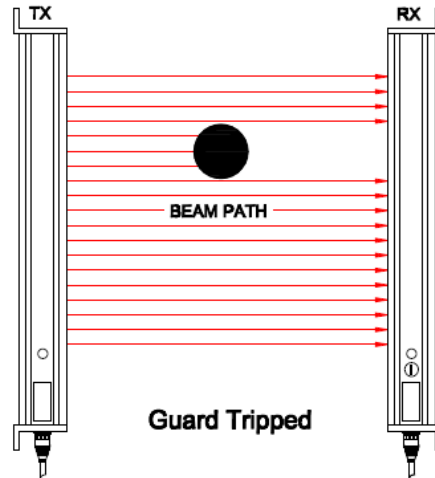

Transmitter Column (TX)

Receiver Column (RX)

- Power ON (Red) **PWR**
- Alignment ON (Green) **STAT**
- Mute ON (Yellow) **MUT**
- Mute 1 ON (Blue) **MU1**
- Mute 2 ON (Blue) **MU2**

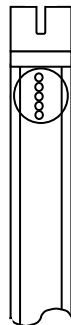

- ON** OSSD's ON (Green)
- OFF** OSSD's OFF (Red)
- LO1** OSSD Fault (Yellow)
- LO2** Mute Disparity Fault (Yellow)
- EDM** EDM (Yellow)

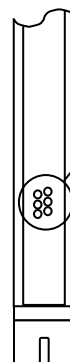
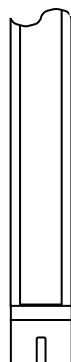

- DIP 1 (RD)
- DIP 2 (YE)
- DIP 3 (GN)
- DIP 4 (BU)
- DIP 5 (RD)
- DIP 6 (OR)

All of these dipswitch indicators LED's maybe be blue in color if the model number starts with 054 (054-XXX)

Status Indicators

Transmitter Indicators

Top of transmitter column

Power ON (**PWR**): Indicates that the transmitter column has power. LED ON

Alignment OK (**STAT**): Indicates light curtain is aligned (On). LED ON

Mute ON (**MUT**): Indicates that the light curtain is in the "MUTED" state. LED turns ON.

Mute 1 ON (**MU1**): Indicates that the light curtain has received external mute signal 1 (ON)

Mute 2 ON (**MU2**): Indicates that the light curtain has received external mute signal 2 (ON)

Receiver Indicators

Top of receiver column

OSSD's ON (**ON**): Indicate that the safety outputs are energized (ON). LED ON

OSSD's OFF (**OFF**): Indicates that the safety outputs are de-energized (OFF) LED ON.

OSSD Fault: (**LO1**) OSSD fault detected LED ON.

Mute Disparity (**LO2**): Mute Disparity fault detected. LED ON

External Device Monitoring (**EDM**): Indicates that the EDM circuit is complete. LED ON

Bottom of receiver column

Dip switches (1- 6): Indicate when dip switches are in the on position. LED ON

Dipswitch 1 = Red LED

Dipswitch 2 = Yellow LED

Dipswitch 3 = Green LED

Dipswitch 4 = Blue LED

Dipswitch 5 = Red LED

Dipswitch 6 = Orange LED

General Set-up Diagnostics

If during set-up LED OSSD's Fault and Mute Disparity start to flash alternately this is due to the Transmitter (TX) head cable not being connected.

If the Power LED starts to flash during set-up the Receiver (RX) head cable is not connected.

If OSSD Fault on the RX head turns on it shows that the light curtain safety outputs (OSSDs) have gone to a fault condition. This means that the light curtain is in a lockout condition and will remain in this condition until the power to the light curtain is re-cycled. The lockout fault is caused by either the OSSD being shorted or the OSSD has been driven higher than the 50mA maximum specification.

T4HD: Controls Diagram

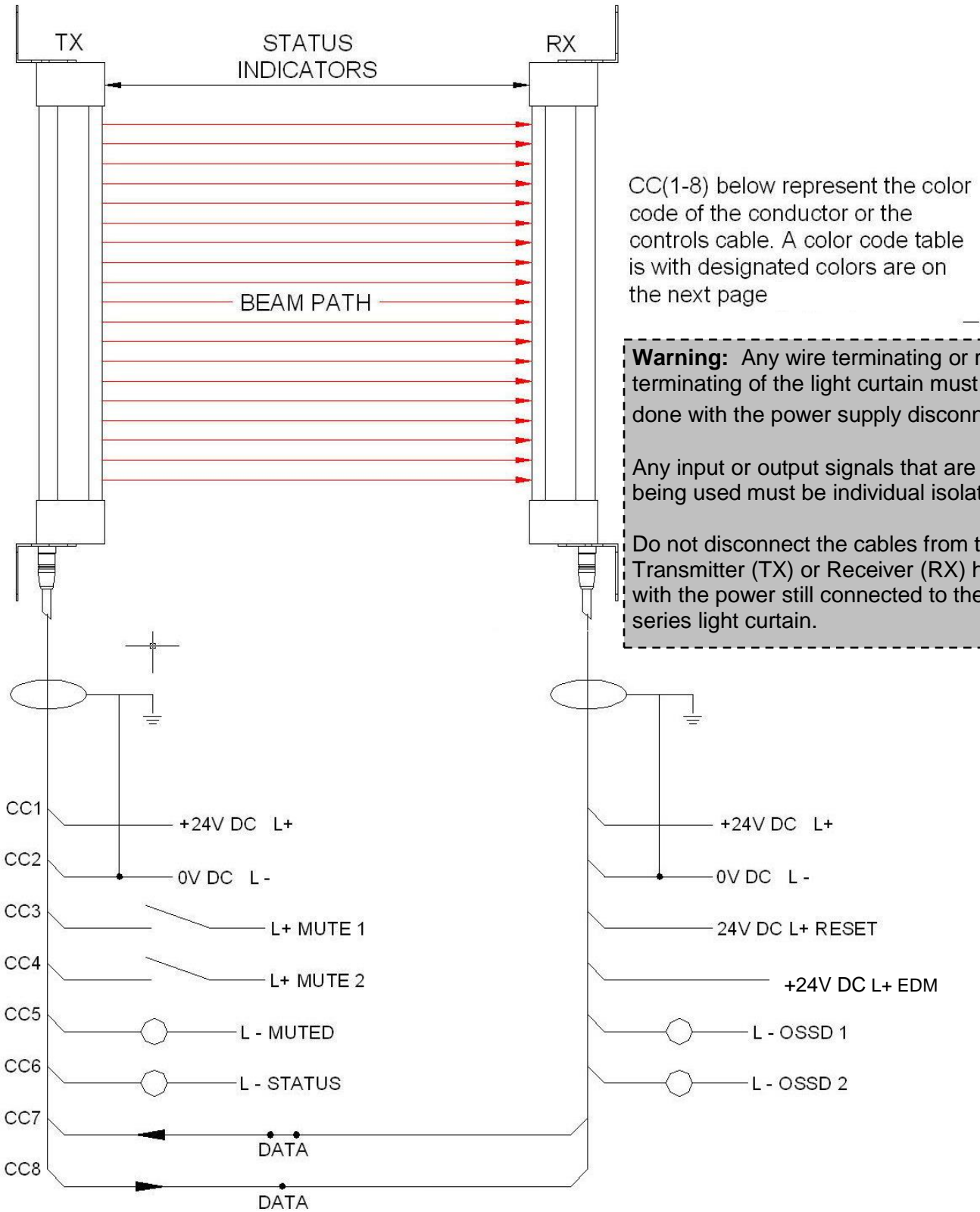

CC(1-8) below represent the color code of the conductor or the controls cable. A color code table with designated colors are on the next page

Warning: Any wire terminating or re-terminating of the light curtain must be done with the power supply disconnected.

Any input or output signals that are not being used must be individual isolated.

Do not disconnect the cables from the Transmitter (TX) or Receiver (RX) head with the power still connected to the T4HD series light curtain.

****DO NOT CONNECT DATA TO +24V DC****

T4HD: Color Code Table

The Color Code numbers (CC#) refer to the conductors of the cable connector below. The cable type is determined by the color of the cable connector (Orange, Black). Each cable type has a different color code. Please make sure that the correct cable type is selected before you begin.

Color Code#	Orange Connector	Black Connector	Cable Pin #
CC1	White	Red	1
CC2	Brown	Gray	2
CC3	Green	Brown	3
CC4	Yellow	Orange	4
CC5	Gray	Yellow	5
CC6	Pink	Green	6
CC7	Blue	Blue	7
CC8	Red	Purple	8

M12 Connector Pin Out

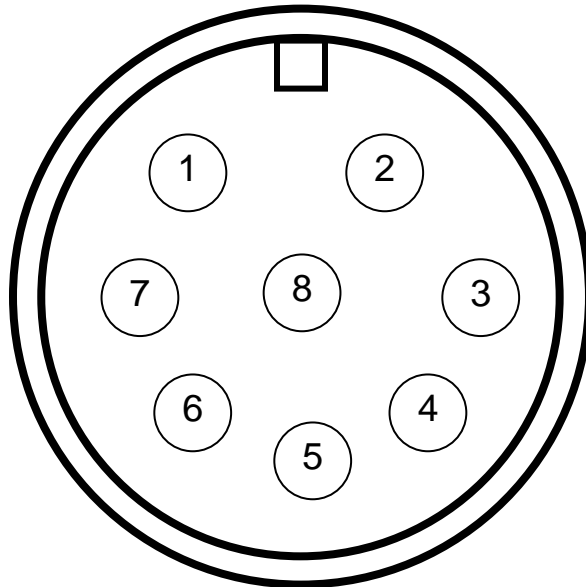

T4HD: Controls

Power supply - Use a regulated supply +24V DC $\pm 10\%$. Protect the +24V input with a 2 A fuse. Connect the power supply to both the transmitter (TX) and receiver (RX) cables as follows: Connect conductors CC1 to +24V DC and CC2 to 0V DC. Shield of the cables should be connected to 0V dc

PWR LED (Red): LED ON = Power Connected

Warning- The shield cables must be connected to 0vdc failure to do so may cause intermittent tripping and/or damage to the light curtain.

EDM (External Device Monitoring) - This input is used to monitor external switching devices to ensure those devices respond each and every time the light curtain is interrupted. There is an LED indicator located in the receiver (RX) column that illuminates when the EDM circuit is complete.

When monitoring a switching device one side of the Normally Closed circuit will connect to conductor CC4 of the **receiver (RX)** cable the other side to +24V DC. If the EDM function is not required +24Vdc must be connected to the conductor CC4 otherwise the system will remain tripped and will not reset.

EDM LED (Yellow): LED ON = EDM On LED OFF = EDM Off

Note: - If EDM is not applied properly the light curtains OSSD's will remain OFF.

Reset - A push button or key switch is required. To give the system a manual restart signal apply +24Vdc to conductor CC3 of the **receiver (RX)** cable, releasing the switch will restart the safety outputs to an ON condition, providing the light curtain is clear of obstruction. If using a PLC to pulse the reset signal the pulse width should be 100 ms or more. For more information about reset modes see page 11.

Safety Outputs (OSSD's) – These two electronic safety outputs respond to interruption of the light curtain (unless muted or blanked). The safety outputs provide +24Vdc (ON) when the curtain is clear of obstruction and 0Vdc (OFF) when the curtain is blocked. They are monitored 24Vdc@500mA signals additionally there are status LED's located in the top of the receiver column that illuminate when the safety outputs are in the ON or OFF state.

OSSD1 (Safety Output 1): To complete the safety circuit CC5 of the **receiver (RX)** cable must be connected to 0Vdc.

OSSD2 (Safety Output 2): To complete the safety circuit CC6 of the **receiver (RX)** cable must be connected to 0Vdc.

ON LED (Green): OSSD (1 & 2) LED On = Light Curtain Clear

OFF LED (Red): OSSD (1 & 2) LED On = Light Curtain Blocked

Warning: - OSSD's should be wired to prevent machine operation unless the OSSD's are in the ON state.

Warning - Bypassing the light curtain safety outputs (OSSD's) has been known to cause serious injury including death

T4HD: Controls

Status Output – The status output is an electronic NON-SAFETY output that is ON = +24Vdc when the safety outputs (OSSD's) are ON and OFF = 0vdc when the safety outputs are OFF. The status contact is a 24Vdc@500mA output.

Status Output: To complete the status output circuit conductor CC6 of the **transmitter (TX)** cable must be connected to 0Vdc.

Mute Inputs (Mute1, Mute2) - Mute inputs (Mute 1, Mute 2) are mute inputs that should be applied to suitable external mute initiating devices. Both mute inputs (mute1 & mute 2) must switch within 2 seconds of each other or the light curtain will not mute (The time interval known as disparity, can be change via dipswitches in the Learned Mode of the light curtain see page 14) When both inputs are active ON (receive 24Vdc), the light curtain will mute (*full mute or **partial mute), e.g. the guards' safety outputs (OSSD's) will not respond to an interruption of the light curtain. The light curtain will remain muted for a maximum time (15 minutes or infinite) that can be selected via dipswitch 3 in the standard mode (see page 11). Additionally there are mute LED indicators located in the top of the transmitter (TX) column that illuminate when the mute signals are applied. Once either of the mute inputs is deactivated (turned OFF) the system will remain muted for an additional 2 seconds as a default. The mute delay off time can be adjusted in the learned mode see page 14.

*Full Mute: The entire sensing region of the light curtain will mute. (Default)

Partial Mute: A window (specified number of beams) will mute; the remainder of the light curtain is active. Selectable via dipswitches in the **Learned mode.

Mute1: To apply mute 1 signal conductor CC3 of the **transmitter (TX)** cable must receive a +24Vdc signal.

Mute2: To apply mute 2 signal conductor CC4 of the **transmitter (TX)** cable must receive a +24Vdc signal.

MU1 LED (Blue): LED On = Mute 1 input applied LED Off = Mute 1 input not applied
MU2 LED (Blue): LED On = Mute 2 input applied LED Off = Mute 2 input not applied

Note: - The external mute input signals should come from separate sources so that a single fault cannot cause a failure of protective function.

Note: - If mute inputs do not agree within specified time (Disparity) the system will not mute and LO2 indicator (Yellow) on receiver (RX) unit will illuminate.

Note: - System will not mute if mute inputs are applied to light curtain before system is powered up or while cycling power.

T4HD: Controls

Mute Output - Some machines require a mute signal to indicate that the light curtain is muted. The mute output is an electronic NON-SAFETY output that is ON =+24Vdc when the light curtain is muted and OFF = 0vdc when the light curtain is not muted. This electronic output is rated 24VDC@500mA and has a status LED located in the transmitter (TX) column that illuminates when the light curtain is muted.

Mute Output: To complete the mute output circuit conductor CC5 of the **transmitter (TX)** cable must be connected to 0Vdc.

MUT LED (Yellow): LED On = Mute On LED Off = Mute Off

Communication Link - The communication conductors must be connected properly for the system to work, they relay information between the transmitter and receiver columns. Connect CC7 of the transmitter (TX) to CC7 of the receiver (RX). Connect CC8 of the transmitter (TX) to CC8 of the receiver (RX).

Warning - Do not apply any other voltage sources to the communication conductors this will damage the light curtain system and void warranty.

The maximum total cable length from the transmitter (TX) unit to the receiver (RX) unit must not exceed 40 meters.

General Set-up Diagnostics

If during set-up LED LO1 and LO2 start to flash alternately this is due to the Transmitter (TX) head cable not being connected.

If the Power LED starts to flash during set-up the Receiver (RX) head cable is not connected.

If the LO1 LED on the RX head turns on it shows that the light curtain safety outputs (OSSDs) have gone to a fault condition. This means that the light curtain is in a lockout condition and will remain in this condition until the power to the light curtain is re-cycled. The lockout fault is caused by either the OSSD being shorted or the OSSD has been driven higher than the 50mA maximum specification.

T4HD: Dip Switch Settings

The dip switches are located under the removable door on the end cap (near the cable connector) of the receiver column (labeled RX). The dipswitches should only be accessed by qualified persons.

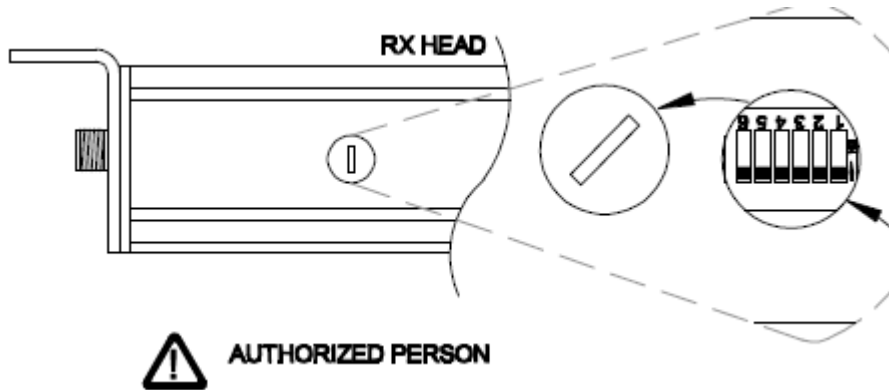

NOTE: Once dipswitches are accessed remember to place protective cover back to its original position to prevent contaminants from entering the light curtain.

There are two modes of dip switch setting for the T4HD light curtain system:

Direct Settings Learn Settings.

Direct settings are the functions that are available “out of the box”. No steps are needed to reach these functions. Place the dipswitches in the desired position, cycle power then the functions are selected. There are (4) four features available in the Direct Settings mode:

- 1) Floating blanking
- 2) Mute dwell time
- 3) Modes
- 4) Parity

Note: To implement dip switch settings or change the dip switch settings requires the light curtain power to be turned off and then on again.

Below is a diagram of the dipswitches in the Direct Setting mode:

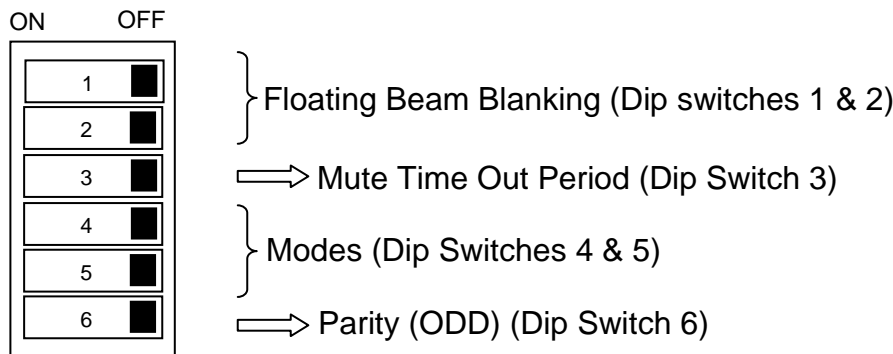

Note: If the parity check is set incorrectly, or any dipswitch is changed while the light curtain is in operation the OSSDs (outputs) will turn OFF. See page19 for parity information.

Floating Beam Blanking

Floating beam blanking allows the user to create a larger unprotected opening in the light curtain safe guarding barrier. The name floating beam blanking originated due to the fact that the disabled beams are not fixed at a specific location. The light curtain will allow a specified number of beams (Maximum of 3 adjacent beams) to be blocked without it sending a stop signal to the safe guarded machine. Floating blanking allows the operator to manipulate the work piece safely without shutting down the machine. There are four options, 1) OFF, 2) 1 beam, 3) 2 adjacent beams and 3) 3 Adjacent beams. These options are selectable at dipswitches 1 & 2 in the direct settings mode.

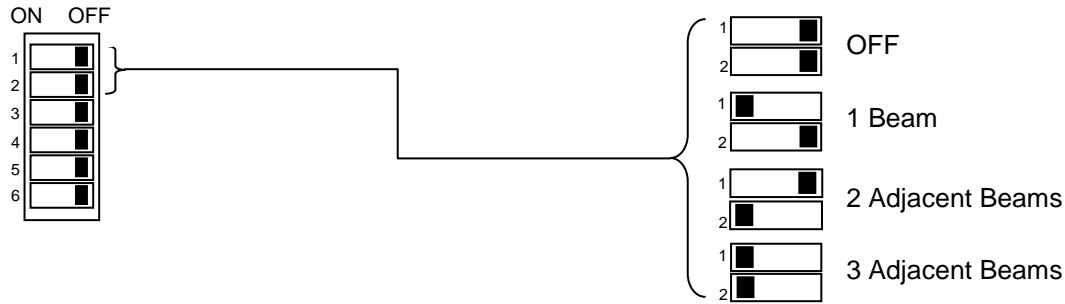

Floating Beam Blanking (14 mm Detection Capability)				
Beams Blanked	0	1	2	3
Object Detection Capability (ODC)	14 mm	24 mm	33mm	43 mm

Floating Beam Blanking (30 mm Detection Capability)				
Beams Blanked	0	1	2	3
Object Detection Capability (ODC)	30 mm	55 mm	80 mm	105 mm

Floating Beam Blanking (40 mm Detection Capability)				
Beams Blanked	0	1	2	3
Object Detection Capability (ODC)	40 mm	63 mm	88 mm	113 mm

Warning: Use of floating beam blanking will change the light curtains object detection capability and could require the light curtain to be move a further distance from the danger area (increase of safety distance) Applicable safety distance standards should be applied when using floating beam blanking.

Note: Multiple object blockages in the light curtains sensing region will cause the OSSD's to turn OFF.

Note: If the parity check is set incorrectly, or any dipswitch is changed while the light curtain is in operation the OSSDs (outputs) will turn OFF. See page19 for parity information.

Mute Dwell Time

Mute dwell is the amount of time that the light curtain can remain in the muted state. There are two options: 1) 15 minutes and 2) Infinite. These options are selectable at dipswitch 3 in the direct settings mode. **Note:** If the parity check is set incorrectly, or changed while the light curtain is in operation the OSSDs (outputs) will turn OFF. See page 19 for parity information

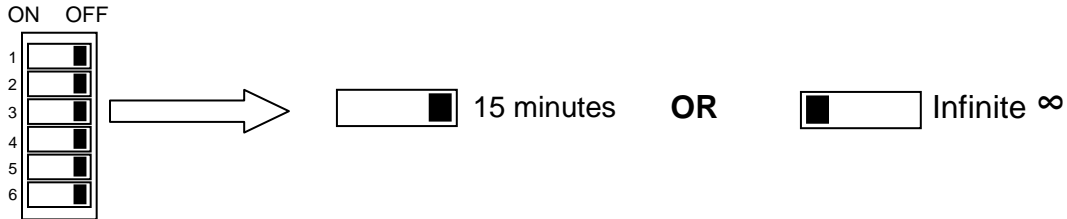

Modes of Operation

Automatic Reset: After initial “Power Up” the light curtain OSSD’s become active (OSSD’s are “ON”). If the light curtains sensing unit is blocked the OSSD’s turn “OFF”. Once the obstruction has been removed from the sensing unit the light curtain automatically reactivates itself. (OSSD’s turn “ON”).

Manual reset (Latched): After initial “Power Up” the light curtains OSSD’s remain “OFF” until a Reset signal is received. Once the reset signal is received the OSSD’s turn “ON”. If tripped, once the obstruction has been removed from the sensing unit the OSSD’s will remain “OFF” until a reset signal is applied, upon which time the OSSDs will turn “ON”.

Restart Interlock mode: After initial “Power Up” the light curtains OSSD’s become active (OSSD’s turn “ON”). If the light curtains sensing unit is blocked the OSSD’s turn “OFF”. Once the obstruction has been removed from the sensing unit the OSSD’s will remain “OFF” until a reset signal is applied

Learned mode: Is the mode that allows the user to access additional features of the light curtains. These features include, fixed beam blanking, partial muting and mute disparity /mute delay off options. See page 21 to see how to enter learned mode & select options.

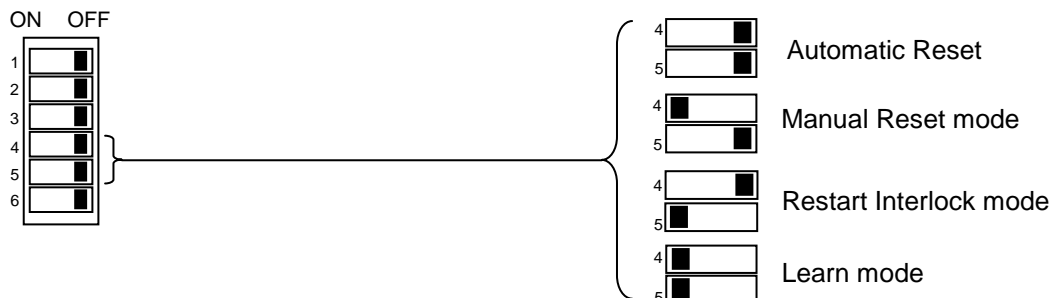

Parity (ODD)

The parity switch (Position 6) is used as a functionality check for the dip switches, making sure no dip switch has failed. The light curtain counts how many of the 6 switches are in the ON position. This sum must be an odd number. If the number is not odd then the systems OSSD's will remain OFF. Below are examples of ODD parity.

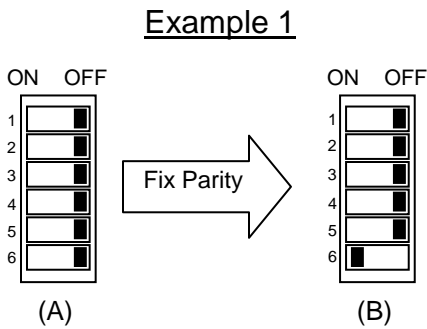

Example 1

Zero dip switches are in the ON position (A). Zero is not an ODD number. **The OSSD's will remain OFF** until the parity switch is move to the ON position (B).

Example 2

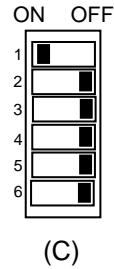

Example 2

One dip switch is in the ON position (C). One is an ODD number. OSSD's will turn ON.

Example 3

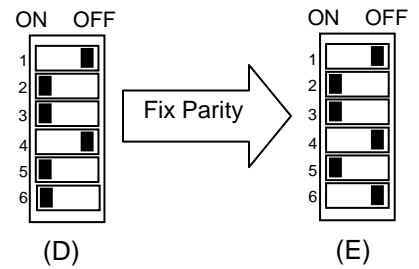

Example 3

Four dip switches are in the ON position (D). Four is not an ODD number. **The OSSD's will remain OFF** until the parity switch is move to the OFF position (E).

If the number of dip switches (1-5) in the ON position equals an even number then parity switch (Position 6) must be in the ON position. If the number of switches in the ON position equals an odd number then parity switch (position 6) must be in the OFF position. Having set the switches in this way, if any switch subsequently fails, either on or off, the parity will go to an even number and the fault will be detected.

Note: If the parity check is set incorrectly, or changed while the light curtain is in operation the OSSDs will turn OFF

Learned Mode

Learned Mode is the mode that allows the user to access the following functions: Fixed beam blanking, Partial (fixed beam) Muting, Mute Disparity/ Mute Delay OFF and Clear. Note: Parity is not required in learned mode.

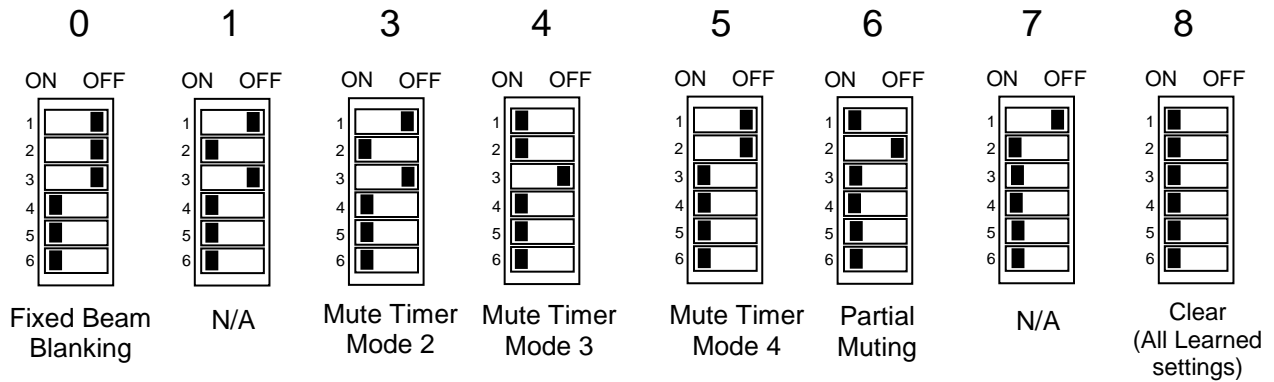

The following steps are required to enter the **Learned Mode**. Diagram below mirrors steps required.

Step 1: Turn Power OFF.

Step 2: Place dip switches in any desired learned settings configuration

Step 3: Turn Power ON.

Once power turns ON. The all LED's in top the Receiver column (RX) will turn ON steady. At this time the safety outputs (OSSD's will remain OFF). The light curtain is now in **Learned Mode**.

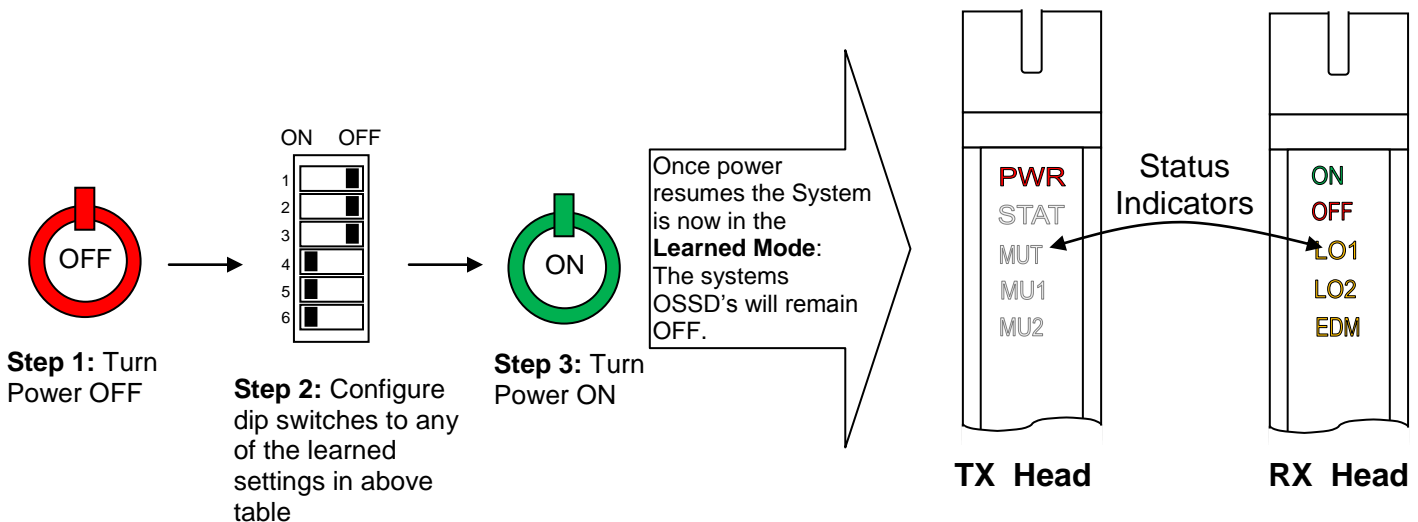

Warning: The two hard-wired mute input connections to the light curtain must be disconnected when using the Learn mode.

Exit Learned Mode

To exit the Learned Mode: Turn off the power, apply one of the three start up modes: 1) Automatic restart, 2) Standard or 3) Restart Interlock. (For explanations of these modes, see page 19). Then turn the power ON.

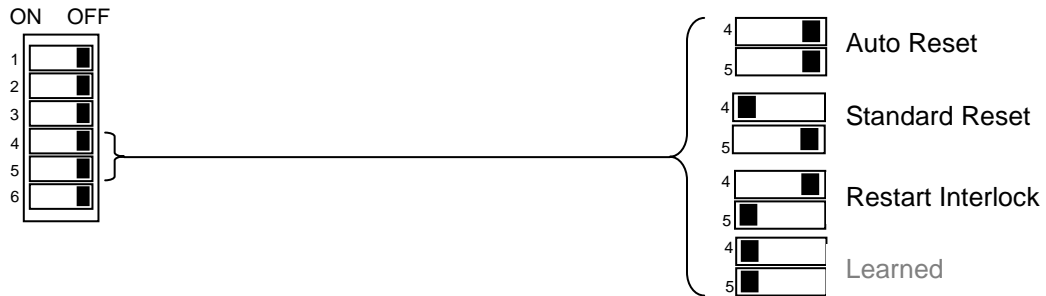

Note: If the parity check is set incorrectly, or changed while the light curtain is in operation the OSSDs (outputs) will turn OFF. See page 20 for parity information.

Fixed Beam Blanking

Fixed beam blanking allows the user to deselect a fixed area of beams in the Light Curtain's sensing field. This is typically used when stationary objects, fixtures, tables, etc are permanently obstructing a portion of the sensing field. The remaining unobstructed area of the light curtains sensing field remains active and if something obstructs the active sensing a signal is sent to the OSSD's unless other features are applied (i.e. muting, floating blanking)

Warning: Use of fixed beam blanking could change the light curtains object detection and could require the light curtain to be move a further distance from the danger area (increase of safety distance).

Warning: If fixed object located in the sensing region does not completely cover the light curtains sensing region additional guarding will be required.

NOTE: Once the sensing region is fixed blanked, removal of the object in that region will cause the OSSD's to remain OFF.

NOTE: Three beams must remain un-blanked in the sensing region of the light curtain, if not OSSD's remain OFF.

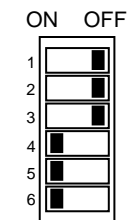
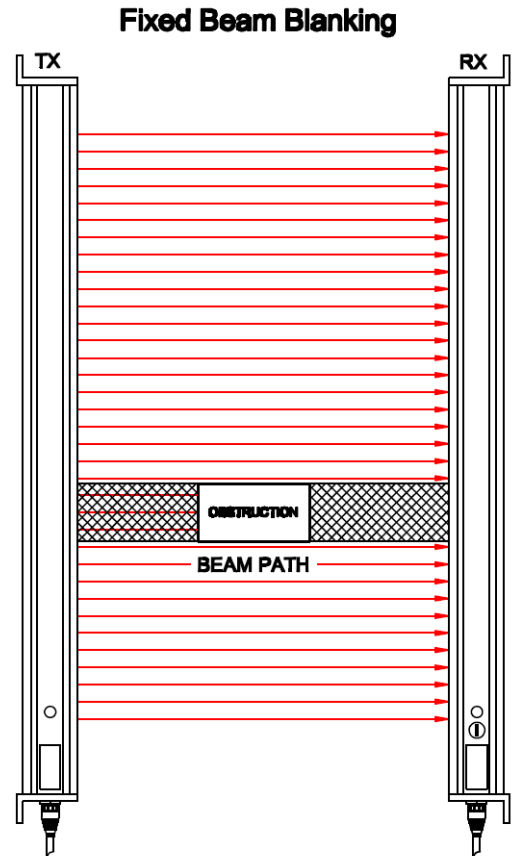

Fixed Beam Blanking

This feature is available in the **Learned Mode**. To configure Fixed Beam Blanking using the following steps:

- 1) Turn power OFF.
- 2) Configure dipswitches as in the diagram to the left
- 3) Place obstruction in light curtain. Obstruction can be placed in light curtain upon original startup.
- 4) Turn power ON wait for All LED's to illuminate in Rx column
- 5) Apply Exit Learned Mode procedure (See page 21) if finished with learned mode or apply another feature.

Partial Muting

Partial Muting allows the user to define a specified area (window) of the light curtain to be muted. Not the entire sensing region of the system.

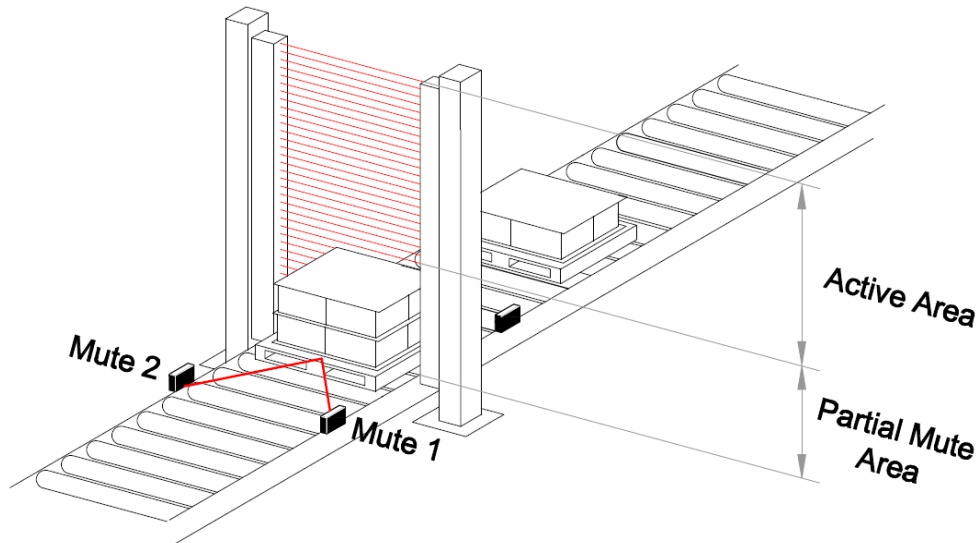

This feature is available in the **Learned Mode**. Configure Partial Muting using the following steps:

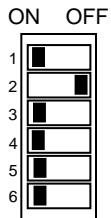

Partial Muting

- 2) Turn power OFF
- 3) Configure dipswitches as in the diagram to the left
- 4) Place product that is to index through the in light curtain when muted in the light curtain's sensing region.
- 5) Turn power ON wait for All LED's to illuminate in Rx column
- 6) Apply Exit Learned Mode procedure (See page 21) if finished with learned mode or apply another feature.

Mute Timer Mode 2

Mute timer mode 2 has a mute disparity of 2 seconds with a mute delay off of 1 seconds. Mute disparity is the time period that the mute inputs (Mute 1 & Mute 2) have to agree (Mute inputs both ON). Once either of the mute inputs is deactivated (turned OFF) the system will remain muted for an additional 1 seconds in mute timer mode 3.

The default disparity is 2 seconds and 2 second mute delay off.



Mute Timer
Mode 2

This feature is available in the **Learned Mode**. Configure Mute Input Disparity using the following steps:

- 1) Turn power OFF
- 2) Configure dipswitches as in the diagram to the left
- 3) Turn power ON wait for All LED's to illuminate in Rx column (see page 13)
- 4) Apply Exit Learned Mode procedure (See page 14) if done with learned mode or apply another feature.

Mute Timer Mode 3

Mute timer mode 3 has a mute disparity of 4 seconds with a mute delay off of 2 seconds. Mute disparity is the time period that the mute inputs (Mute 1 & Mute 2) have to agree (Mute inputs both ON). Once either of the mute inputs is deactivated (turned OFF) the system will remain muted for an additional 2 seconds in mute timer mode 3.

The default disparity is 2 seconds and 2 second mute delay off.



Mute Timer
Mode 3

This feature is available in the **Learned Mode**. Configure Mute Input Disparity using the following steps:

- 5) Turn power OFF.
- 6) Configure dipswitches as in the diagram to the left
- 7) Turn power ON wait for All LED's to illuminate in Rx column
- 8) Apply Exit Learned Mode procedure (See page 21) if finished with learned mode or apply another feature.

Mute Timer Mode 4

Mute timer mode 4 has a mute disparity of 200 milliseconds with a mute delay off of 0 seconds. Mute disparity is the time period that the mute inputs (Mute 1 & Mute 2) have to agree (Mute inputs both ON). Once either of the mute inputs is deactivated (turned OFF) the system will remain muted for an additional 0 seconds in mute timer mode 4.

The default disparity is 2 seconds and 2 second mute delay off.

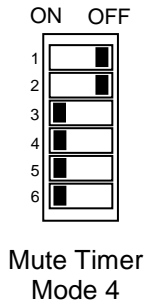

This feature is available in the **Learned Mode**. Configure Mute Input Disparity using the following steps:

- 1) Turn power OFF
- 2) Configure dipswitches as in the diagram to the left
- 3) Turn power ON wait for All LED's to illuminate in Rx column
- 4) Apply Exit Learned Mode procedure (See page 21) if finished with learned mode or apply another feature.

Clear

Clears all features applied in the Learned Mode, returning the system to its original factory settings.

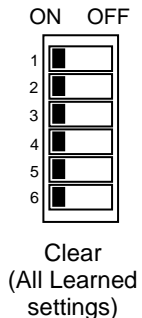

This feature is available in the **Learned Mode**. To clear all the features applied in the Learned Mode use following steps:

- 1) Turn power OFF
- 2) Configure dipswitches as in the diagram to the left
- 3) Turn power ON wait for All LED's to illuminate in Rx column
- 4) Apply Exit Learned Mode procedure (See page 21) if finished with learned mode or apply another feature.

Original Factory Settings	
Disparity	2 seconds
Mute Dwell Time	15 minutes
Fixed Beam Blanking	OFF
Partial Muting	OFF
Floating Beam Blanking	OFF
Mute Delay OFF	2 seconds

T4HD: Specifications

Number of beams	1 – 128
Detection height	141 – 2391 mm
Range	Perimeter guard - 15 meters model dependent 14mm guard - 4 meters 30 mm guard - 6 meters 40 mm guard - 15 meters
Light type	IR 880nm
Response time	20ms
Operating temperature	-30°C to +50°C (-22°F - 122°F)
Light curtain enclosure	•IP67 (See Smartscan for more information)
Power supply	24V DC
Current consumption	1.5A maximum
Cables	Max. 40 meter length total (both TX & RX)
Light curtain connection	M12 - •IP65
Finish	Aluminum chromate treated, yellow polyester powder coated
Classification	EN 61496-1 Type 4 IEC 61496-2 Type 4 EN 954-1 Category 4 EN 61508 SIL 3 EN 13849 PL: e
Warranty	1 Year

OUTPUTS	
Safety Outputs OSSD1 & OSSD2	ON = +24Vdc Electronic 500mA: Dual control reliable.
Status Output	ON = +24Vdc; Electronic 500mA
Mute Output	ON = +24Vdc; Electronic 500mA
Status and Mute Indication	Status & condition LED's on Light Curtain

INPUTS	
Safety Monitoring (EDM)	ON = +24Vdc
Reset	ON = +24V DC
Muting	Dual mute inputs. ON = +24Vdc

- For more information about IP or wash down rating contact Smartscan.

T4HD: Dimensions

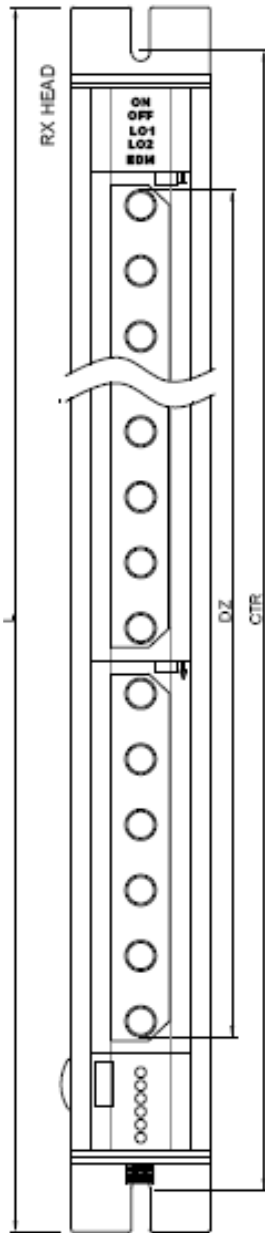

DZ = L-149 mm
CTR = L- 26 mm

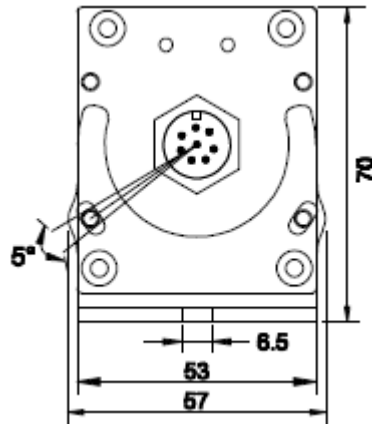

All dimensions are in mm.
The dimension (**L**) can be found in the light curtain model number table.

NOTE: Older models may have a prefix of 054-XXX all dimensional information for these older models is the same as below.

T4HD: 30mm Object Detection Capability (0.5 - 6 meter range)

Model number	Item number	Number of beams	Detection height (mm)	Overall length (L) mm
T4HD-30-06	056-301	6	141	290
T4HD-30-12	056-302	12	291	440
T4HD-30-18	056-303	18	441	590
T4HD-30-24	056-304	24	591	740
T4HD-30-30	056-305	30	741	890
T4HD-30-36	056-306	36	891	1040
T4HD-30-42	056-307	42	1041	1190
T4HD-30-48	056-308	48	1191	1340
T4HD-30-54	056-309	54	1341	1490
T4HD-30-60	056-310	60	1491	1640
T4HD-30-66	056-311	66	1641	1790
T4HD-30-72	056-312	72	1791	1940
T4HD-30-78	056-313	78	1941	2090
T4HD-30-84	056-314	84	2091	2240
T4HD-30-90	056-315	90	2241	2390
T4HD-30-96	056-316	96	2391	2540

T4HD: 40mm Object Detection Capability (3 - 15 meter range)

Model Number	Item Number	Number of beams	Detection height (mm)	Overall length (L) mm
T4HD-40-06	056-401	6	141	290
T4HD-40-12	056-402	12	291	440
T4HD-40-18	056-403	18	441	590
T4HD-40-24	056-404	24	591	740
T4HD-40-30	056-405	30	741	890
T4HD-40-36	056-406	36	891	1040
T4HD-40-42	056-407	42	1041	1190
T4HD-40-48	056-408	48	1191	1340
T4HD-40-54	056-409	54	1341	1490
T4HD-40-60	056-410	60	1491	1640
T4HD-40-66	056-411	66	1641	1790
T4HD-40-72	056-412	72	1791	1940
T4HD-40-78	056-413	78	1941	2090
T4HD-40-84	056-414	84	2091	2240
T4HD-40-90	056-415	90	2241	2390
T4HD-40-96	056-416	96	2391	2540

NOTE: Older models may have a prefix of 054-XXX all dimensional information for these older models is the same as below.

T4HD: Range of Light Curtains 14mm ODC (0.5-4 meter range)

Model Number	Item number	Number of beams	Detection height (mm)	Overall length (L) mm
T4HD-14-06	056-101	16	141	290
T4HD-14-12	056-102	32	291	440
T4HD-14-18	056-103	48	441	590
T4HD-14-24	056-104	64	591	740
T4HD-14-30	056-105	80	741	890
T4HD-14-36	056-106	96	891	1040
T4HD-14-42	056-107	112	1041	1190
T4HD-14-48	056-108	128	1191	1340

T4HD: Perimeter Guarding (0.5-6 meter range)

Model Number	Item Number	Number of Beams	Detection height (mm)	Overall length (L) mm
T4HD-305-24	056-605	12	600	749
T4HD-230-36	056-606	18	900	1049
T4HD-385-48	056-607	18	1200	1349
T4HD-305-60	056-608	24	1549	1649
T4HD-90-72	056-609	30	1800	1949
T4HD-95-84	056-610	30	2100	2249
T4HD-105-96	056-611	36	2400	2549

T4HD: Perimeter Guarding (3-15 meter range)

Model Number	Item Number	Number of Beams	Detection height (mm)	Overall length (L) mm
T4HD-305-24P	056-612	12	600	749
T4HD-230-36P	056-613	18	900	1049
T4HD-385-48P	056-614	18	1200	1349
T4HD-305-60P	056-615	24	1500	1649
T4HD-90-72P	056-616	30	1800	1949
T4HD-95-84P	056-617	30	2100	2249
T4HD-105-96P	056-618	36	2400	2549

T4HD: Interconnect Cables

Model Number	Item Number	Cable Length (Meters)
T4CAB-05	050-005	5
T4CAB-10	050-010	10
T4CAB-20	050-020	20